

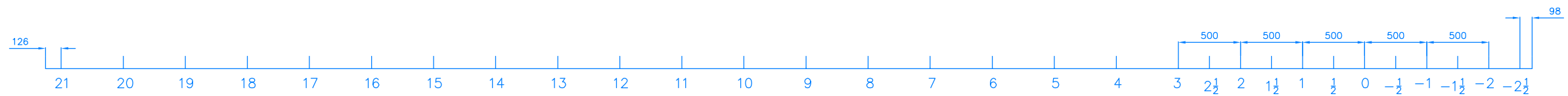

PROFILE

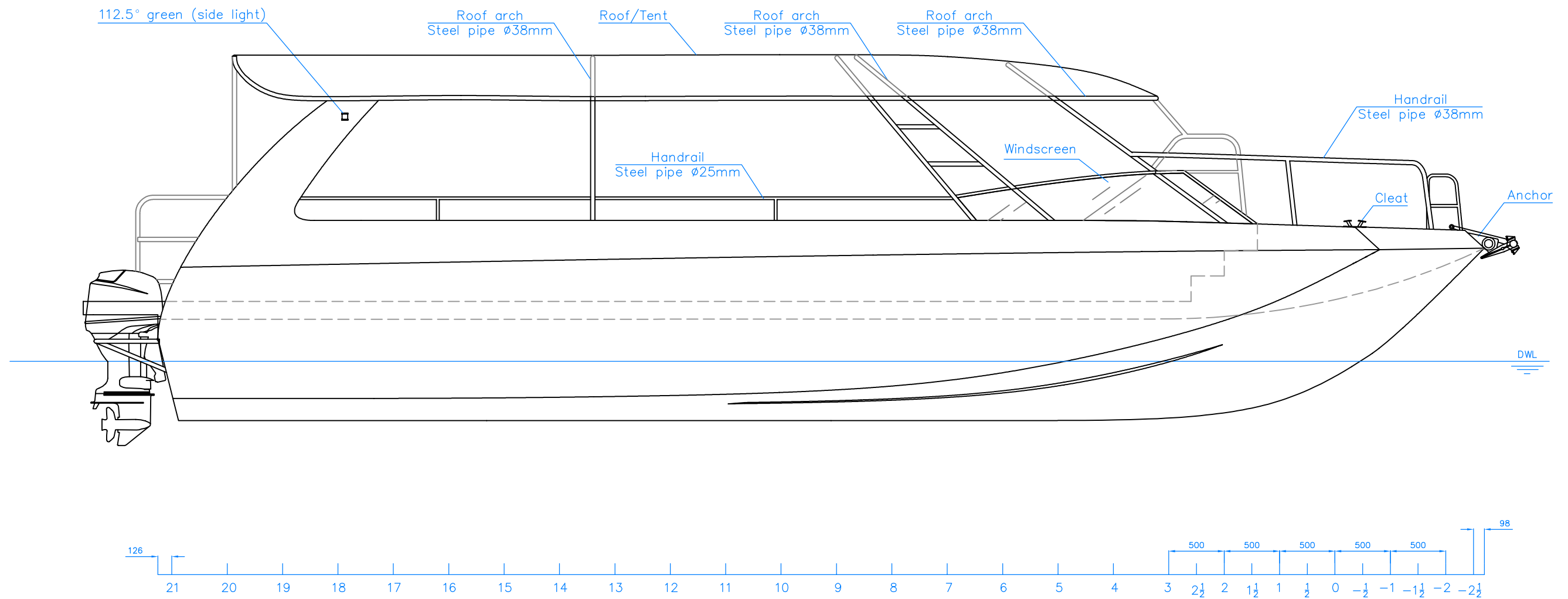

No.	Date:	Designed:	Description:	Checked:	Approved:
REVISIONS					

THIS DRAWING IS THE PROPERTY OF ALBATROSS MARINE DESIGN CO.,LTD AND MUST NOT BE REPRODUCED OR USED FOR ANY PURPOSE, OTHER THAN IN CONJUNCTION WITH THE PROJECT OR DESIGN FOR WHICH IT WAS DRAWN, WITHOUT ALBATROSS MARINE DESIGN'S PRIOR WRITTEN CONSENT. COPYRIGHT © ALBATROSS MARINE DESIGN.

PROFILE

Design:	KC1200
Title:	GENERAL ARRANGEMENT
Drawing No:	KC1200.L0.01
Client:	



Date:	26/01/2017	Scale:	1:40
Sheet 01	Sheets 1	Edition	V3
Designed:			
Checked:			
Approved:			
Filename:	KC1200_L0.dwg		



TOP VIEW

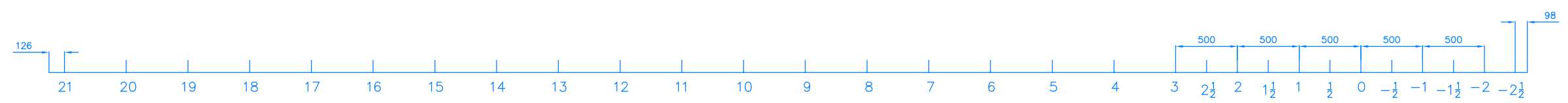
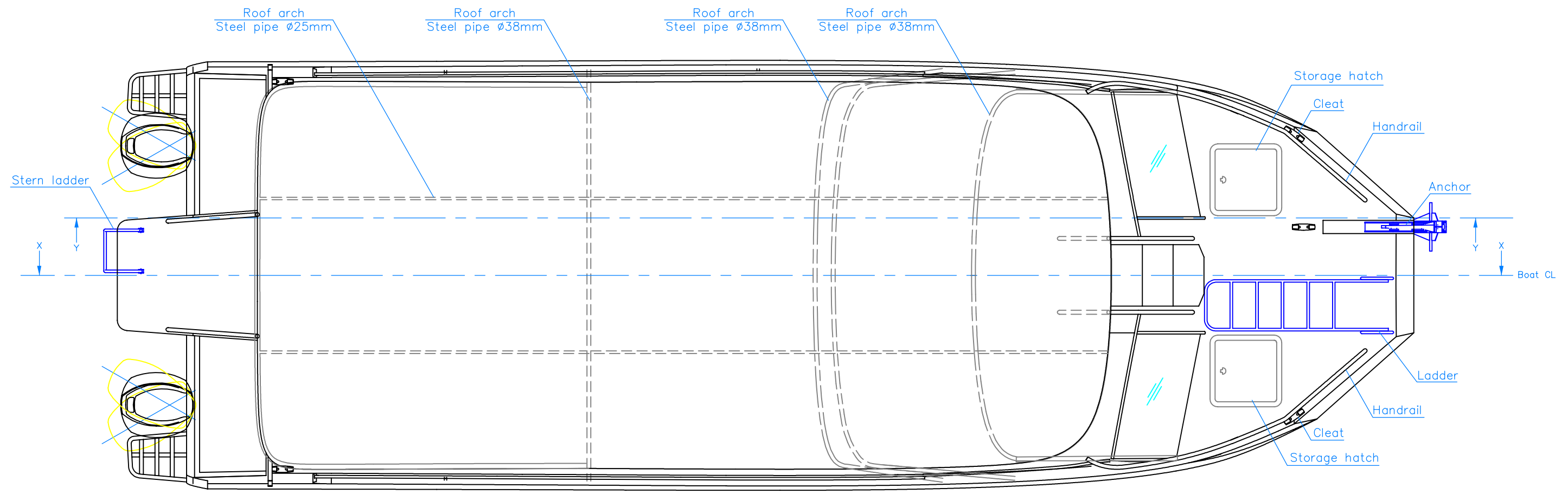

No.	Date:	Designed:	Description:	Checked:	Approved:
REVISIONS					

THIS DRAWING IS THE PROPERTY OF ALBATROSS MARINE DESIGN CO.,LTD AND MUST NOT BE REPRODUCED OR USED FOR ANY PURPOSE, OTHER THAN IN CONJUNCTION WITH THE PROJECT OR DESIGN FOR WHICH IT WAS DRAWN, WITHOUT ALBATROSS MARINE DESIGN'S PRIOR WRITTEN CONSENT. COPYRIGHT © ALBATROSS MARINE DESIGN.

TOP VIEW

Design:	KC1200
Title:	GENERAL ARRANGEMENT
Drawing No:	KC1200.L0.02
Client:	



Date:	26/01/2017	Scale:	1:40
Sheet 01	Sheets 1	Edition	V3
Designed:			
Checked:			
Approved:			
Filename:	KC1200_L0.dwg		

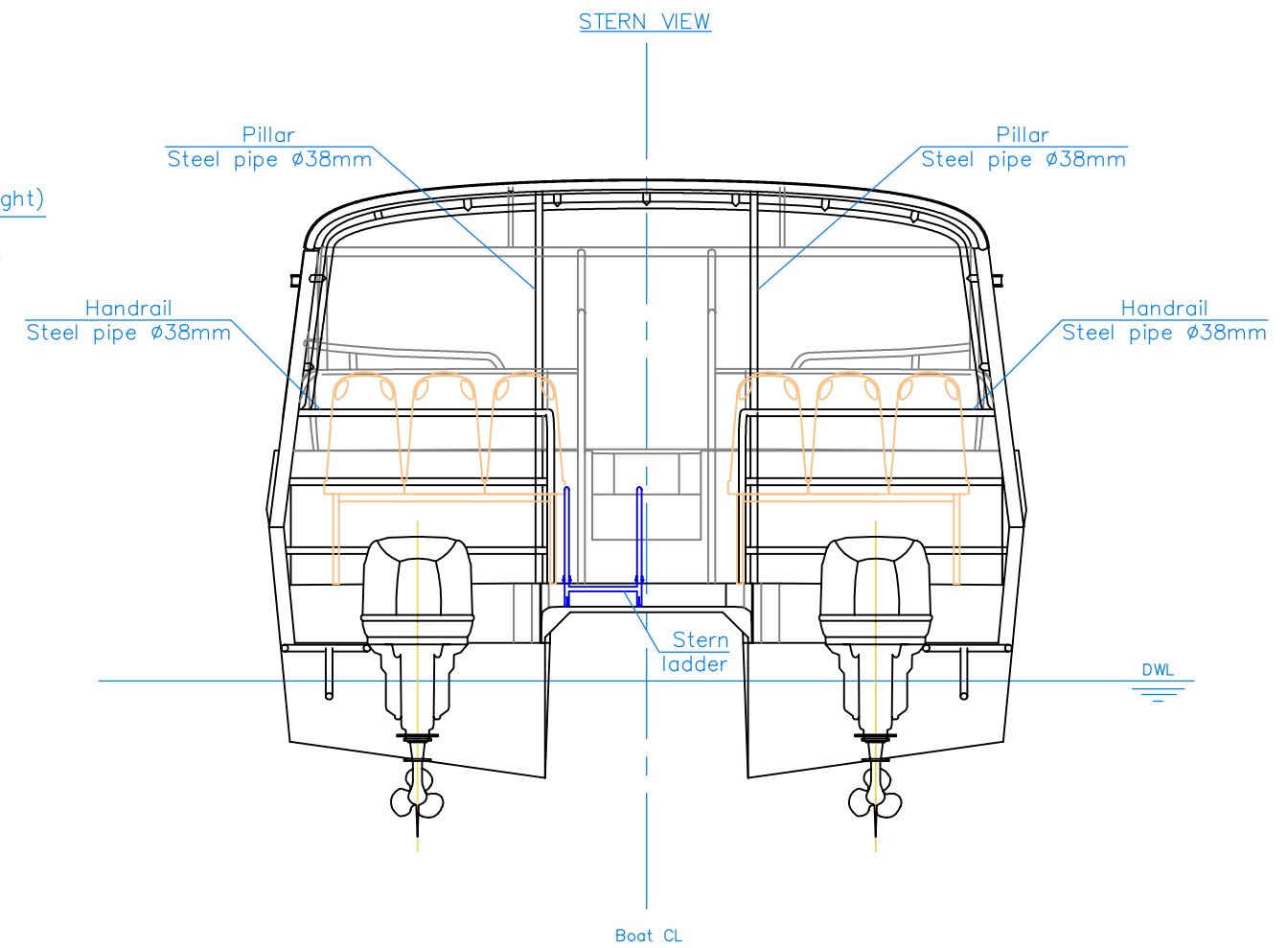
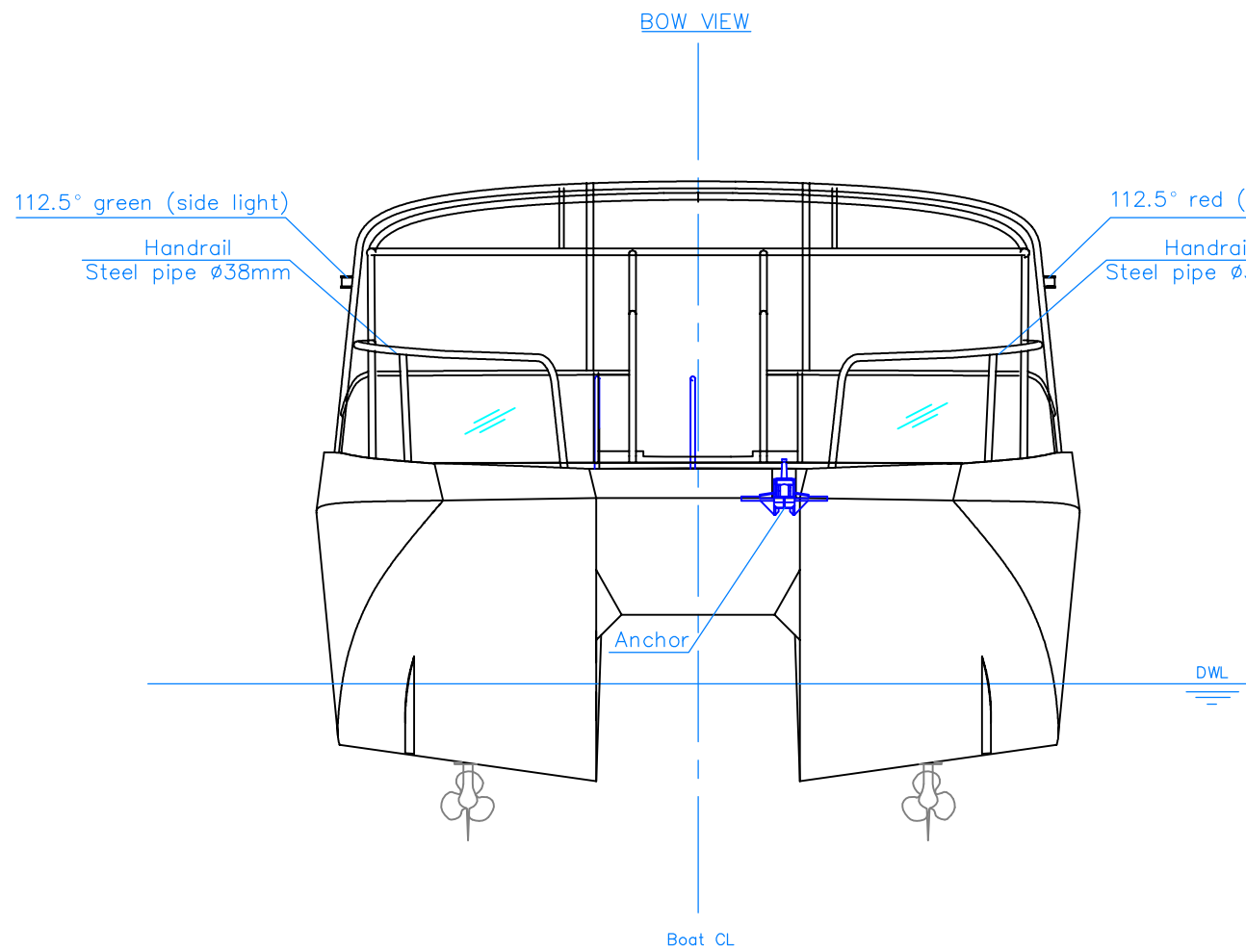

No.	Date:	Designed:	Description:	Checked:	Approved:
REVISIONS					

THIS DRAWING IS THE PROPERTY OF ALBATROSS MARINE DESIGN CO.,LTD AND MUST NOT BE REPRODUCED OR USED FOR ANY PURPOSE, OTHER THAN IN CONJUNCTION WITH THE PROJECT OR DESIGN FOR WHICH IT WAS DRAWN, WITHOUT ALBATROSS MARINE DESIGN'S PRIOR WRITTEN CONSENT. COPYRIGHT © ALBATROSS MARINE DESIGN.

BOW VIEW, STERN VIEW

Design:	KC1200
Title:	GENERAL ARRANGEMENT
Drawing No:	KC1200.L0.03
Client:	

ALBATROSS
MARINE DESIGN

ALBATROSS MARINE DESIGN CO., LTD
Rattanak Building, 29/73 MB Sukhumvit Rd.,
Nongruk, Banglamung, Chonburi 20150 THAILAND
Info@albatross.co.th www.albatross.co.th
Phone: +66 38416881 Fax: +6636 416882

Date:	26/01/2017	Scale:	1:40
Sheet 01	Sheets 1	Edition:	V3
Designed:			
Checked:			
Approved:			
Filename:	KC1200_L0.dwg		

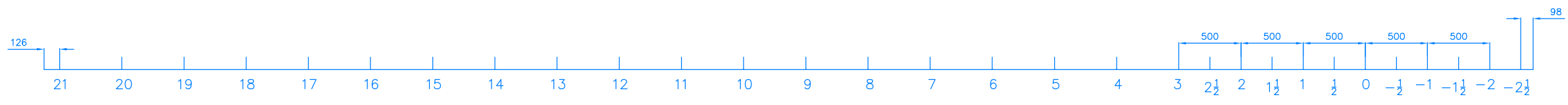
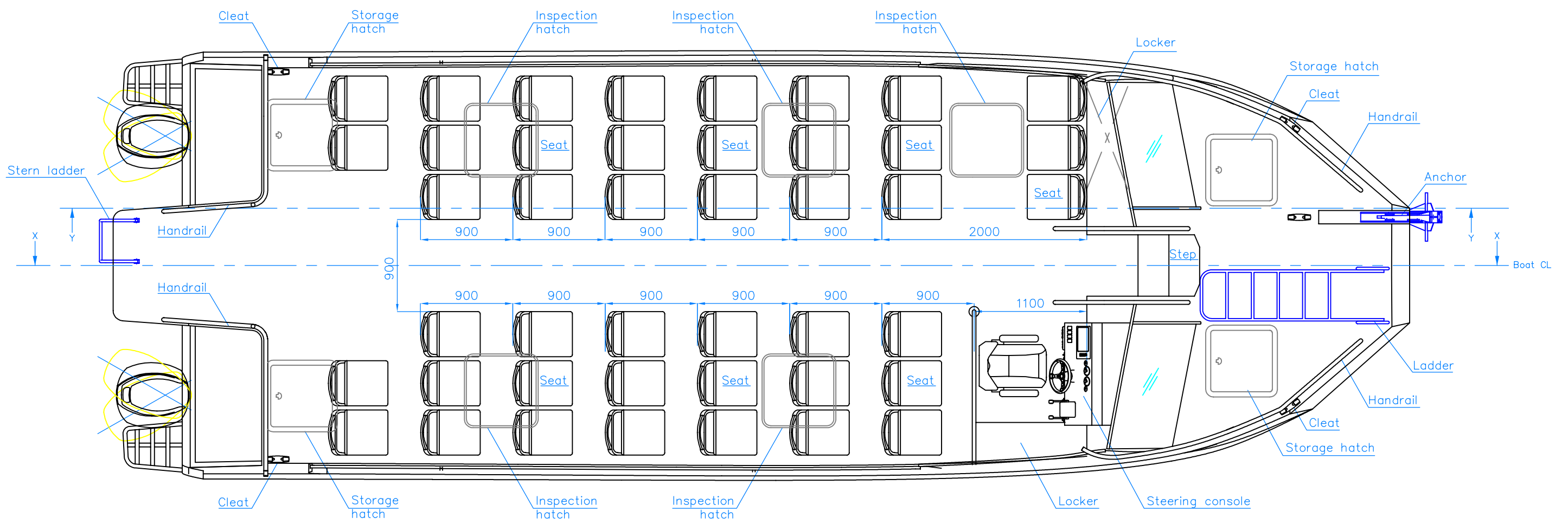

No.	Date:	Designed:	Description:	Checked:	Approved:
REVISIONS					

THIS DRAWING IS THE PROPERTY OF ALBATROSS MARINE DESIGN CO.,LTD AND MUST NOT BE REPRODUCED OR USED FOR ANY PURPOSE, OTHER THAN IN CONJUNCTION WITH THE PROJECT OR DESIGN FOR WHICH IT WAS DRAWN, WITHOUT ALBATROSS MARINE DESIGN'S PRIOR WRITTEN CONSENT. COPYRIGHT © ALBATROSS MARINE DESIGN.

DECK PLAN

Design:	KC1200
Title:	GENERAL ARRANGEMENT
Drawing No:	KC1200.L0.04
Client:	



Date:	26/01/2017	Scale:	1:40
Sheet 01	Sheets 1	Edition	V3
Designed:			
Checked:			
Approved:			
Filename:	KC1200_L0.dwg		

0 1 2m
 BOAT CENTERLINE SECTION X-X
 Looking to STBD

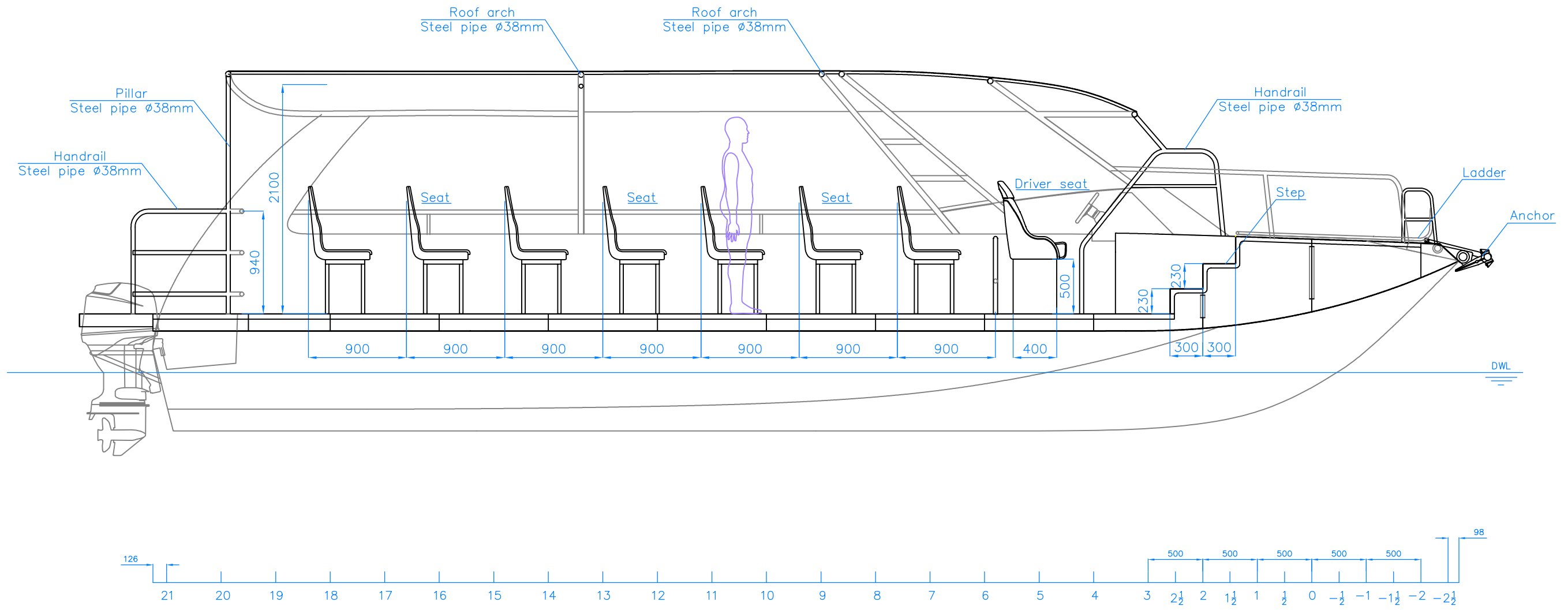

No.	Date:	Designed:	Description:	Checked:	Approved:
REVISIONS					

THIS DRAWING IS THE PROPERTY OF ALBATROSS MARINE DESIGN CO.,LTD AND MUST NOT BE REPRODUCED OR USED FOR ANY PURPOSE, OTHER THAN IN CONJUNCTION WITH THE PROJECT OR DESIGN FOR WHICH IT WAS DRAWN, WITHOUT ALBATROSS MARINE DESIGN'S PRIOR WRITTEN CONSENT. COPYRIGHT © ALBATROSS MARINE DESIGN.

BOAT CENTERLINE SECTION

Design:	KC1200
Title:	GENERAL ARRANGEMENT
Drawing No:	KC1200.L0.05
Client:	



Date:	26/01/2017	Scale:	1:40
Sheet 01	Sheets 1	Edition	V3
Designed:			
Checked:			
Approved:			
Filename:	KC1200.L0.dwg		

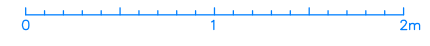

HULL SECTION Y-Y

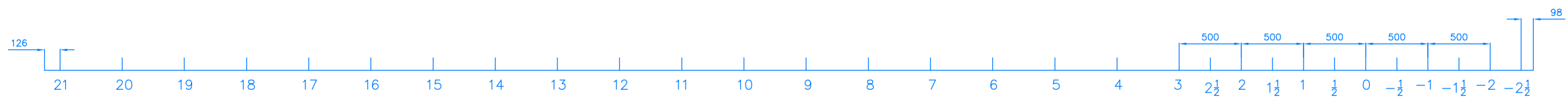
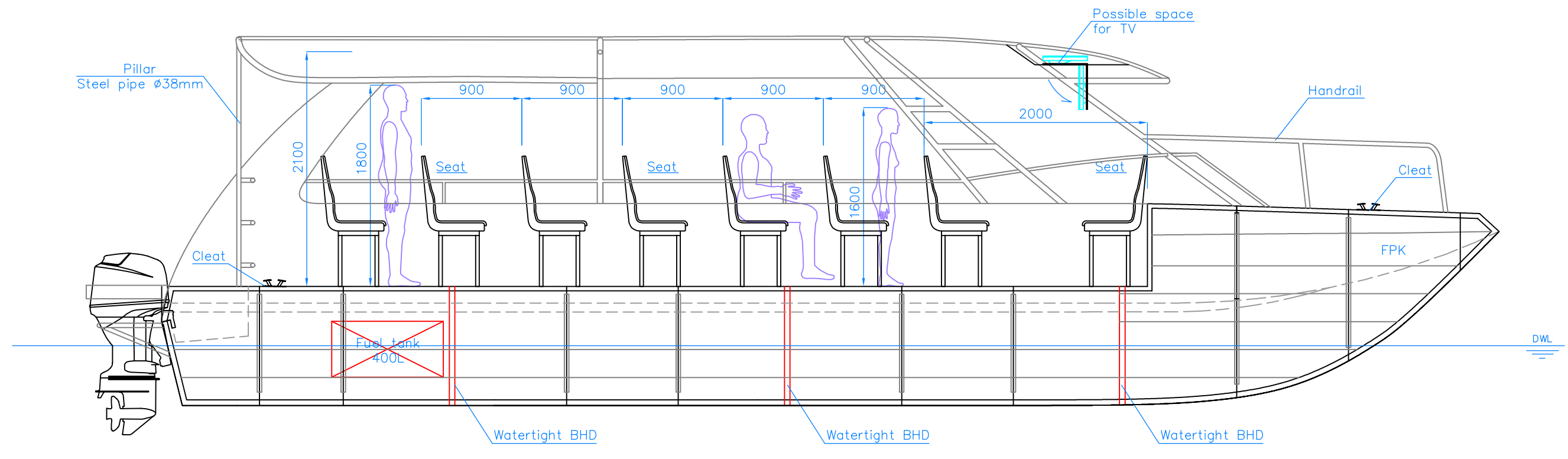

No.	Date	Designed	Description	Checked	Approved
REVISIONS					

THIS DRAWING IS THE PROPERTY OF ALBATROSS MARINE DESIGN CO.,LTD AND MUST NOT BE REPRODUCED OR USED FOR ANY PURPOSE, OTHER THAN IN CONJUNCTION WITH THE PROJECT OR DESIGN FOR WHICH IT WAS DRAWN, WITHOUT ALBATROSS MARINE DESIGN'S PRIOR WRITTEN CONSENT. COPYRIGHT © ALBATROSS MARINE DESIGN.

HULL SECTION

Design:	KC1200
Title:	GENERAL ARRANGEMENT
Drawing No:	KC1200.L0.06
Client:	

ALBATROSS
MARINE DESIGN

ALBATROSS MARINE DESIGN CO., LTD
Rattanak Building, 23/73 MB Sukhumvit Rd.,
Nongrua, Banglamung, Chantrea 20150 THAILAND
Info@albatrossdesign.co.th www.albatrossdesign.co.th
Phone: +66 38416881 Fax: +6636 416882

Date:	26/01/2017	Scale:	1:40
Sheet 01	Sheets 1	Edition:	V3
Designed:			
Checked:			
Approved:			
Filename:	KC1200_L0.dwg		